

Phototransposition Chemistry of Phenylisothiazoles and Phenylthiazoles. 1. Interconversions in Benzene Solution¹

James W. Pavlik,^{*,†} Pakamas Tongcharoensirikul,[†] Nigel P. Bird,[‡] A. Colin Day,[‡] and John A. Barltrop[‡]

Contribution from the Department of Chemistry, Worcester Polytechnic Institute, Worcester, Massachusetts 01609, and The Dyson Perrins Laboratory, Oxford University, Oxford OX1 3QY, England

Received October 25, 1993. Revised Manuscript Received December 30, 1993[⊙]

Abstract: Phenylthiazoles 1-3 and phenylisothiazoles 4-6 undergo phototransposition in benzene solvent mainly by P₅, P₆, and P₇ permutation pathways. Phenylisothiazoles 5 and 6 also transpose *via* a P₄ permutation process to yield phenylthiazoles 2 and 3 in less than 1% yield. In benzene saturated with D₂O, 2-phenylthiazole (1) and 5-phenylisothiazole (6) each phototranspose to yield 4-deuterio-3-phenylisothiazole (4-D-4) and 4-phenylthiazole (2) without deuterium incorporation. Irradiation of 4-phenylthiazole (2) under these conditions results in rapid photodeuteration to yield 2-deuterio-4-phenylthiazole (2-D-2), which subsequently phototransposes to 5-deuterio-3-phenylisothiazole (5-D-3). These experimental results can be rationalized by a mechanism involving initial electrocyclic ring closure and sigmatropic shift of sulfur around the four sides of the azetidine ring. Rearomatization of each bicyclic intermediate thus allows sulfur to insert into each position in the carbon-nitrogen sequence. As a consequence, these compounds divide into a tetrad in which isomers 1, 2, 4, and 6 interconvert mainly *via* P₅, P₆, and P₇ pathways and a dyad of two compounds in which 3 phototransposes to 5 *via* P₅ and P₇ pathways. Within the tetrad, BC-6, the bicyclic intermediate derived from 5-phenylisothiazoles (6), is postulated to undergo deuteration with simultaneous sigmatropic shift of sulfur when the reaction is carried out in benzene-D₂O. This mechanistic view provides one coherent interpretation for the observed phototransposition and photodeuteration reactions.

Introduction

As part of our interest in the phototransposition chemistry of five-membered heterocycles containing two heteroatoms,²⁻⁵ we have undertaken an investigation of the phototransposition reactions of the isothiazole-thiazole heterocyclic system.⁶ Phenylisothiazoles and phenylthiazoles are known to undergo a variety of phototranspositions upon irradiation in benzene solvent.⁷ Although these reactions have been studied in detail by Vernin and his colleagues^{8a-f} in France and in Japan by Maeda and Kojima,^{9a-d} their published work poses a number of unresolved mechanistic and logical questions. In an attempt to resolve these questions, a reinvestigation of the phototransposition chemistry of phenylisothiazoles and phenylthiazoles in benzene solution has been undertaken.

[†] Worcester Polytechnic Institute.

[‡] Oxford University.

• Abstract published in *Advance ACS Abstracts*, February 15, 1994.

(1) Presented in part at the 206th National Meeting of the American Chemical Society, Chicago, IL, August 1993.

(2) Pavlik, J. W.; Kurzweil, E. M. *J. Org. Chem.* 1991, 56, 6313-6320.

(3) Connors, R. E.; Pavlik, J. W.; Burns, D. S.; Kurzweil, E. M. *J. Org. Chem.* 1991, 56, 6321-6326.

(4) Connors, R. E.; Burns, D. S.; Kurzweil, E. M.; Pavlik, J. W. *J. Org. Chem.* 1992, 57, 1937-1940.

(5) Pavlik, J. W.; Connors, R. E.; Burns, D. S.; Kurzweil, E. M. *J. Am. Chem. Soc.* 1993, 115, 7645-7652.

(6) Pavlik, J. W.; Pandit, C. R.; Samuel, C. J.; Day, A. C. *J. Org. Chem.* 1993, 58, 3407-3410.

(7) Lablache-Combier, A. In *Photochemistry of Heterocyclic Compounds*; Buchardt, O., Ed.; Wiley: New York, 1976 p 123. Padwa, A. In *Rearrangements in Ground and Excited States*; de Mayo, P., Ed.; Academic Press: New York, 1980; Vol. 3, p 501.

(8) (a) Vernin, G.; Poite, J.-C.; Metzger, J.; Aune, J.-P.; Dou, J. M. *Bull. Soc. Chim. Fr.* 1971, 1103-1104. (b) Vernin, G.; Jauffred, R.; Richard, C.; Dou, H. J. M.; Metzger, J. *J. Chem. Soc. Perkin Trans 2* 1972, 1145-1150. (c) Vernin, G.; Riou, C.; Dou, H. J. M.; Bouscasse, L.; Metzger, J.; Loidan, G. *Bull. Soc. Chim. Fr.* 1973, 1743-1751. (d) Riou, C.; Poite, J.-C.; Vernin, G.; Metzger, J. *Tetrahedron* 1974, 30, 879-898. (e) Riou, C.; Vernin, G.; Dou, H. J. M.; Metzger, J. *Bull. Soc. Chim. Fr.* 1972, 2673-2678. (f) Vernin, G.; Poite, J.-C.; Dou, H. J. M.; Metzger, J. *Bull. Soc. Chim. Fr.* 1972, 3157-3167.

(9) (a) Kojima, M.; Maeda, M. *J. Chem. Soc., Chem. Commun.* 1970, 386-387. (b) Maeda, M.; Kojima, M. *Tetrahedron Lett.* 1973, 3523-3526. (c) Maeda, M.; Kawahara, A.; Kai, M.; Kojima, M. *Heterocycles* 1978, 3, 389-393. (d) Maeda, M.; Kojima, M. *J. Chem. Soc., Perkin 1* 1978, 685-692.

Results and Discussion

Each of the six phenylthiazoles and phenylisothiazoles 1-6, 2.0×10^{-2} M in benzene, was irradiated at 254 nm while the solution was continuously purged with a fine stream of nitrogen. Product formation was monitored as a function of irradiation time by quantitative capillary GLC under conditions that allowed clean separation of the six isomers. Products were identified by co-injection and, when possible, by mass spectroscopic comparison with authentic samples.

Table 1 shows the primary phototransposition products formed from each of the six isomers. In this table the numbers in parentheses represent the absolute quantity of reactant consumed or the percent yield of the product formed^{10,11} after the irradiation time indicated. As shown in the table, 4-phenylthiazole (2) is the least photoreactive of the six isomers. Thus, even after 96 h of irradiation, only a trace quantity of the reactant was consumed and a trace amount of 3-phenylisothiazole (4) detected. Conversely, 4-phenylisothiazole (5) is much more reactive. However, although 74% of 5 was consumed after 1 h of irradiation, no phototransposition or other GLC-volatile products could be detected.¹² The remaining four isomers phototransposed as shown in the table.

Permutation Pattern Analysis. Since each phenylthiazole and phenylisothiazole reactant in Table 1 has two unlabeled ring atoms, each product formed can be rationalized by two different permutation patterns.^{13,14} Thus, 5-phenylisothiazole (6), 4-phenylthiazole (2), and 3-phenylisothiazole (4) could be formed from 2-phenylthiazole (1) by the P₅ or P₁₀, the P₆ or P₉, and the

(10) All yields reported are percent yields determined by quantitative GLC and based on the number of moles of reactant consumed.

(11) GLC analysis of the irradiated solutions did not reveal the formation of any additional volatile products in greater than trace quantities. Preparative-layer chromatography showed a significant band of highly colored material remaining at the origin. NMR analysis of this material showed the absence of thiazole or isothiazole ring protons, indicating that this material resulted from ring-opening reactions presumably involving polymerization.

(12) Under other reaction conditions 4-phenylisothiazole (5) has been observed to undergo efficient phototransposition. These observations will be reported elsewhere.

Table 1. Primary Phototransposition Products

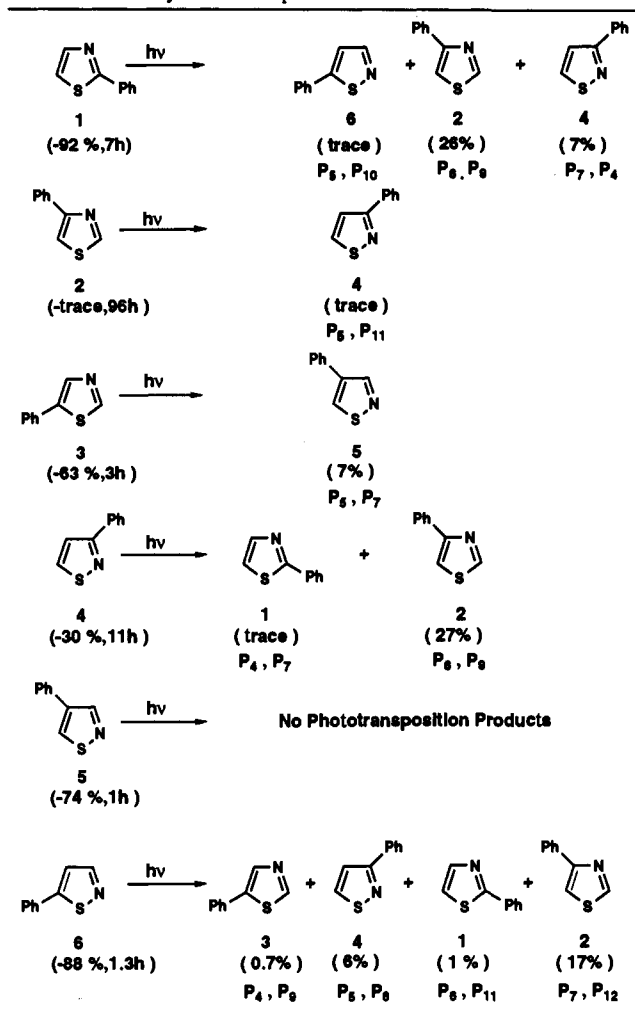

P₇ or P₄ permutation pathways. These ambiguities can be removed by considering the phototransposition products shown in Table 2 obtained from 5-deuterio-2-phenylthiazole (5-D-1), a reactant in which each ring position is uniquely labeled. Thus, as previously reported by Vernin and colleagues,^{8e} analysis of the photoproducts by NMR and/or mass spectroscopy confirms that the deuterium at C-5 of the reactant transposes to ring position 5 in 4-phenylthiazole (2) and to ring position 4 in 3-phenylisothiazole (4) as demanded by the P₆ and P₇ permutation patterns, respectively.¹⁵ The single product, 3-phenylisothiazole (4) formed from 4-phenylthiazole (2) could arise by either the P₅ or P₁₁ pathways. The simplest inference is that, as in the formation of 6 from 1, 4 is formed from 2 also by the P₅ permutation process. This suggestion can also be confirmed by deuterium labeling. Thus as shown in Table 2, Kojima and Maeda^{9d} have previously reported that 2-deuterio-4-phenylthiazole (2-D-2) transposes to 5-deuterio-3-phenylisothiazole (5-D-4) as demanded by the P₅ permutation pattern.

Although the P₅ and P₇ permutation pathways have completely different bond-breaking and bond-forming requirements, per-

(13) For a discussion of permutation pattern analysis in aromatic phototransposition chemistry and in five-membered heteroaromatic phototransposition chemistry, see: Barltrop, J. A.; Day, A. C. *J. Chem. Soc., Chem. Commun.* 1975, 177-179; Barltrop, J. A.; Day, A. C.; Moxon, P. D.; Ward, R. W. *J. Chem. Soc., Chem. Commun.* 1975, 786-787. Barltrop, J. A.; Day, A. C.; Ward, R. W. *J. Chem. Soc., Chem. Commun.* 1978, 131-133.

(14) For five-membered heterocycles containing two heteroatoms there are 12 different ways of transposing the five ring atoms resulting in 12 permutation patterns identified P₁-P₁₂. For a table showing these permutation patterns see ref 2.

(15) These workers did not observe 5-phenylisothiazole (6) as a product in this reaction.

Table 2. Deuterium Labeling Experiments

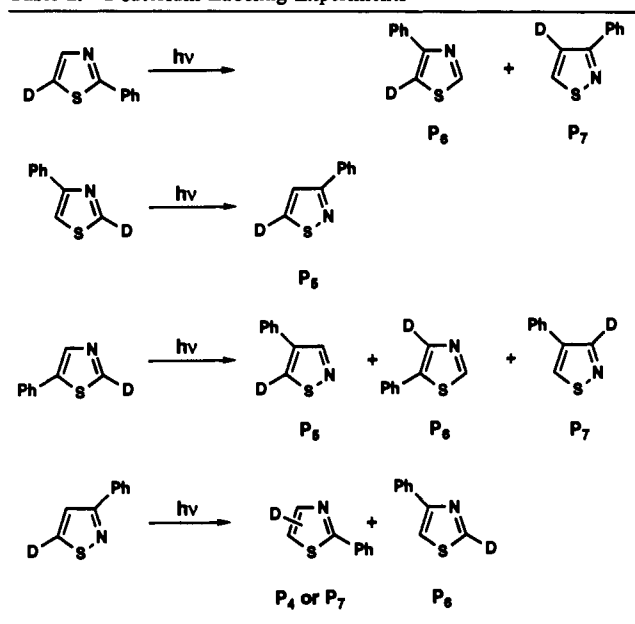

mutation pattern analysis shows that in the case of 5-phenylthiazole (3) these pathways lead coincidentally to the same

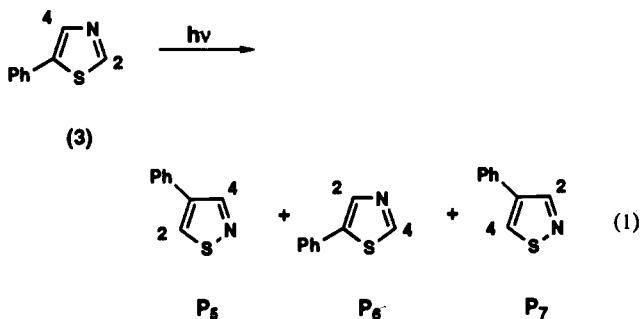

product, 4-phenylisothiazole (5) in which C-2 and C-4 of the reactant, the unlabeled ring atoms, are interchanged in the P₅ and P₇ permutations. Furthermore, this analysis also reveals that the P₆ pathway leads to 5-phenylthiazole (3) with interchange of ring positions 2 and 4.

These ambiguities were resolved by studying the phototransposition chemistry of 2-deuterio-5-phenylthiazole (2-D-3), pre-

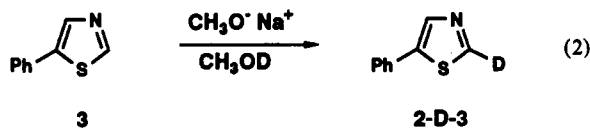

pared by base-catalyzed deuteration of 5-phenylthiazole (3). The ¹H NMR spectrum of 2-D-3 exhibited a one proton singlet at δ 8.06 for the C-4 proton but showed the complete absence of a signal at δ 8.74 for the C-2 proton. Furthermore, the mass spectrum of 2-D-3 exhibited a base peak at *m/e* 162 for 2-D-3 but no detectable peak at *m/e* 161, indicating complete deuteration of 3.

A 2.0 × 10⁻² M solution of 2-D-3 in benzene was irradiated through Pyrex¹⁶ for 18 h while the solution was continuously purged with a fine stream of nitrogen. GLC analysis of the resulting solution showed the consumption of 80% of the reactant

(16) 5-Phenylthiazole has λ_{max} at 275 nm but has appreciable absorption beyond the Pyrex cutoff.

Scheme 1

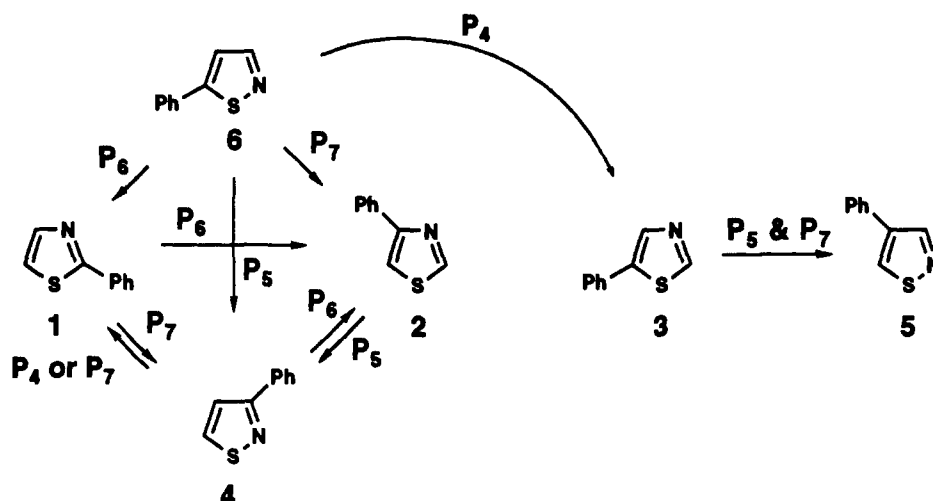

and the formation of a single phototransposition product, deuterated 4-phenylisothiazole (5) in 20% yield.

A major mass spectral fragmentation pathway for 4-phenylisothiazole involves loss of $\text{H C}_3\equiv\text{N}$, resulting in the formation of an m/e 134 fragment.¹⁷ In the mass spectrum of deuterated 4-phenylisothiazole this pathway will lead to loss of either HCN or DCN , leaving either m/e 135 or 134 fragments, depending on whether the deuterium is located at C-5 or C-3 of 4-phenylisothiazole (5). Mass spectral analysis of the deuterated 4-phenylisothiazole phototransposition product exhibited fragments at m/e 135 and 134 in a ratio 1.39:1. These results show that the C-2 deuterium of 5-phenylthiazole (2-D-3) has transposed to position 5 of the 4-phenylisothiazole ring, as demanded by the P_5 permutation pathway, and to position 3, as required by the P_7 permutation process.

In the mass spectrum of 5-phenylthiazole (3), fragmentation involves either loss of $\text{HC}_2\equiv\text{N}$ or $\text{HC}_4\equiv\text{N}$ to leave m/e 134 fragments.¹⁸ In the case of 2-deuterio-5-phenylthiazole (2-D-3), these pathways would result in loss of $\text{DC}_2\equiv\text{N}$ to leave an m/e 134 fragment and loss of $\text{HC}_4\equiv\text{N}$, resulting in an m/e 135 fragment. Before irradiation, the ratio of the m/e 134:135 signals in the mass spectrum of pure 2-D-3 was observed to be 2.68, indicating that loss of C_2 is the major fragmentation pathway. After irradiation, mass spectral analysis of the unconverted deuterated 5-phenylthiazole showed that the ratio had decreased to 2.31, indicating interconversion of the C_2 and C_4 ring positions and, accordingly, interconversion of 2-deuterio-5-phenylthiazole (2-D-3) and 4-deuterio-5-phenylthiazole (4-D-3) via a P_6 transposition pathway.

Scheme 1 summarizes the observed phototranspositions and reveals that the six isomers can be organized into a tetrad in which four isomers interconvert mainly via P_5 , P_6 , and P_7 transposition pathways and a dyad in which 5-phenylthiazole (3) transposes to 4-phenylisothiazole (5) via P_5 and P_7 transposition pathways. No evidence has been observed for the reverse transposition of 5 to 3. With the exception of the low yield of 3 from 6, we observe no interconversion of the tetrad and the dyad in greater than 0.05% yield. These results differ significantly from those previously reported. First, the P_4 transposition of 5-phenylisothiazole (6) to 5-phenylthiazole (3) has not been previously reported. Second, Vernin and his colleagues reported that, in addition to its transposition to 4-phenylisothiazole (5), 5-phenylthiazole (3), a member of the dyad, transposes to 5-phenylisothiazole (6) and 3-phenylisothiazole (4), two members of the tetrad.^{8a,c} These dyad to tetrad interconversions would

Scheme 2

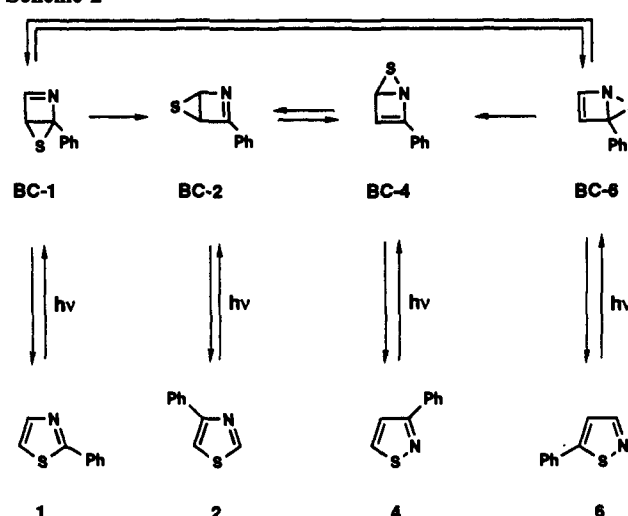

have to occur via either P_4 or P_{11} and P_{10} or P_{12} permutations. These results would be unusual since the P_4 pathway has never been observed from five-membered heterocycles having two heteroatoms in alternate positions, while no five-membered heterocycle has ever been reported to transpose via P_{10} , P_{11} , or P_{12} permutations. In our laboratory we have searched but failed to find these products. Instead, upon irradiation of 5-phenylthiazole (3), in addition to 4-phenylisothiazole (5), we observed a very low yield of one product whose GLC retention is very similar, but not identical, to that of 5-phenylisothiazole (6). Furthermore, the mass spectrum of this unidentified minor photoproduct confirmed that it is not 5-phenylisothiazole (6), as reported by Vernin. Thus, we conclude that with the exception of the one minor P_4 tetrad to dyad interconversion noted, there are no other interconversions between the two groups.

Mechanistic Discussion. The P_5 , P_6 , and P_7 permutation pathways can be rationalized by a mechanism involving electrocyclic ring closure and heteroatom migration as shown in Scheme 2. Thus, photochemical excitation of any member of the tetrad is suggested to result in electrocyclic ring closure, leading directly to the azathiabicyclo[2.1.0]pentene intermediates. The four bicyclic intermediates, and hence, the four members of the tetrad, are interconvertible via 1,3-sigmatropic shifts of the sulfur around the four sides of the azetine ring. Thus, sulfur walk followed by rearomatization allows sulfur insertion into the four different sites in the carbon-nitrogen sequence. According to this mechanism, in principle, irradiation of any one member of the tetrad should lead to the formation of the other three. In

(17) Salmona, G.; Vincent, E.-J. *Org. Mass Spectrom.* 1978, 13, 119-120.

(18) Clarke, G. M.; Grigg, R.; Williams, D. H. *J. Chem. Soc. B* 1966, 339-343.

Scheme 3

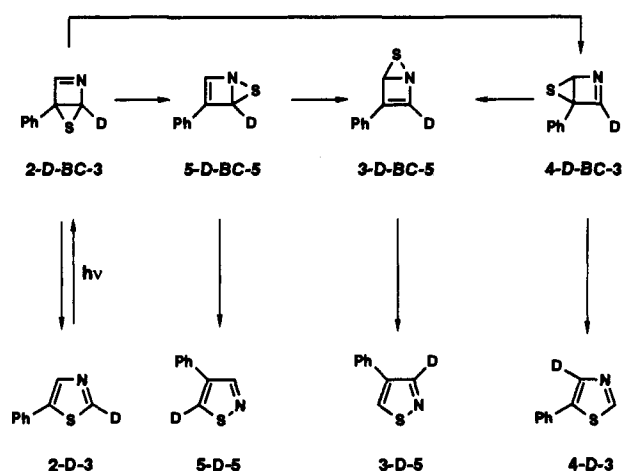

Scheme 4

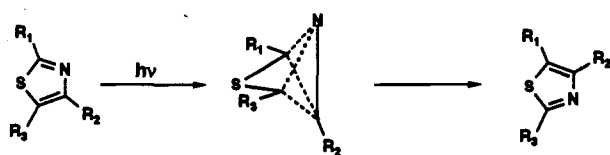

practice, however, 4-phenylthiazole (**2**) is the dominant product from the irradiation of the other three members of the group, and **2** shows little tendency to phototranspose. Both facts presumably reflect the greater stability of **BC-2**, in which the phenyl ring is in conjugation with the polar double bond of the imino group.¹⁹

In the dyad, because of the symmetry of the 5-phenylthiazole (**3**) ring, only two unique sites exist in the C–N sequence. Thus, insertion of sulfur between ring positions C-1 and C-4 or C-1 and C-2 leads to the same compound, 5-phenylthiazole (**3**), while insertion of the sulfur atom between N-3 and C-4 or between N-3 and C-2 leads to 4-phenylisothiazole (**5**). This symmetry is removed in the case of 2-deuterio-5-phenylthiazole (**2-D-3**), and insertion of sulfur between C-1 and C-4 or between C-1 and C-2 results in the C-2 → C-4 deuterium scrambling observed upon irradiation of **2-D-3**, whereas insertion of sulfur between N-3 and C-2 or between N-3 and C-4 results in the C-3 → C-5 deuterium scrambling observed in the deuterated 4-phenylisothiazole phototransposition product. These results are again consistent with electrocyclic ring closure followed by sulfur migration around the four sides of the azetine ring, as shown in Scheme 3.

Although Vernin and colleagues also suggested the intermediacy of azathiabicyclic intermediates in these phototranspositions,^{8c} they concluded that no single mechanism was satisfactory and that a combination of the electrocyclic ring closure-sulfur migration mechanism and the mechanism proposed by Kellogg²⁰ for thiophene phototranspositions was necessary to explain the observed results.^{8c} As shown in Scheme 4, this latter mechanism involves intermediates in which two of the ring atoms are located in a plane perpendicular to that containing the other three atoms. For thiazoles there are five such structures, and each one permits the interchange of two adjacent ring atoms. Such intermediates could not only account for the observed phototranspositions but would also predict other transposition pathways not observed. Accordingly, we see no compelling reason to evoke their intermediacy in these phototransposition reactions.

Based on their studies of deuterium incorporation during phototransposition, Maeda and Kojima proposed that tricyclic

zwitterions are critical intermediates in these reactions.^{9d} According to their proposed mechanism (Scheme 5), all members of the tetrad are photochemically converted to the same tricyclic zwitterionic species, **TZ-1**. This intermediate was then suggested to partition between conversion to bicyclic intermediates **BC-1** and **BC-2**, the precursors of 2-phenylthiazole (**1**) and 4-phenylthiazole (**2**), and S–N bonding to provide **TZ-2**, which subsequently opens to **BC-4** and **BC-6**, the precursors of 3-phenylisothiazole (**4**) and 5-phenylisothiazole (**6**). Since interconversion of the four bicyclic intermediates was specifically precluded by Maeda and Kojima,^{9d} this mechanism demands that 4-phenylthiazole (**2**) and 3-phenylisothiazole (**4**) should be formed in the same ratio from either 5-phenylisothiazole (**6**) or 2-phenylthiazole (**1**). Our experimental results are not consistent with this requirement. Thus, we find that 4-phenylthiazole (**2**) and 3-phenylisothiazole (**4**) are formed in a ratio of 3.1 ± 0.1 from 5-phenylisothiazole (**6**), while from 2-phenylthiazole (**1**) the ratio of the two transposition products is 8.5 ± 0.3 . These results are clearly not consistent with Maeda's and Kojima's tricyclic zwitterion mechanism.

The tricyclic zwitterion mechanism also fails to quantitatively explain the deuterium scrambling observed upon irradiation of 2-deuterio-5-phenylthiazole (**2-D-3**). According to the tricyclic zwitterion mechanism shown in Scheme 6, the 5-deuterio-4-phenylisothiazole (**5-D-5**) to 3-deuterio-4-phenylisothiazole (**3-D-5**) ratio would be determined by the secondary deuterium isotope effect on breaking the S–C–H bond as compared to the S–C–D bond in **TZ-4**. Typical values for such isotope effects have been reported to range from 0.87 to 1.26.^{21,22} In the present case, however, mass spectral analysis of the deuterated 4-phenylisothiazole photoproduct shows that 5-deuterio-4-phenylisothiazole (**5-D-5**) and 3-deuterio-4-phenylisothiazole (**3-D-5**) were formed in a ratio 1.39:1. This indicates that the ratio is not being controlled by the secondary isotope effect as required by the tricyclic zwitterion mechanism.

Although these results cannot be rationalized by the tricyclic zwitterion mechanism, they arise logically from the electrocyclic ring closure-sulfur migration mechanism shown in Scheme 2. In terms of this mechanism the ratio of 4-phenylthiazole (**2**) to 3-phenylisothiazole (**4**) is expected to be larger when they are formed from 2-phenylthiazole (**1**) than from 5-phenylisothiazole (**6**). This is anticipated since 4-phenylthiazole (**2**) is formed from **1** via a single sulfur walk, $1 + h\nu \rightarrow \text{BC-1} \rightarrow \text{BC-2} \rightarrow 2$, while 3-phenylisothiazole (**4**) is formed from **1** via a double-walk process. Since **4** transposes to **2** but not to **6**, this implies that **BC-4** rearranges to the more stable **BC-2** but not to the less stable **BC-6**. Furthermore, since 5-phenylthiazole (**6**) is formed along with 3-phenylisothiazole (**4**) and 4-phenylthiazole (**2**) from 2-phenylthiazole (**1**), this implicates **BC-6** on the transposition pathway and indicates that at least a portion of **4** is formed via the pathway $1 + h\nu \rightarrow \text{BC-1} \rightarrow \text{BC-6} \rightarrow \text{BC-4} \rightarrow 4$ and that **6** cannot arise via the route $1 + h\nu \rightarrow \text{BC-1} \rightarrow \text{BC-2} \rightarrow \text{BC-4} \rightarrow \text{BC-6} \rightarrow 6$.

The ratio of **2** to **4** formed from 5-phenylisothiazole (**6**) is smaller because in this case it is 3-phenylisothiazole (**4**) which is formed via a single sulfur walk, $6 + h\nu \rightarrow \text{BC-6} \rightarrow \text{BC-4} \rightarrow 4$, whereas 4-phenylthiazole (**2**) is now formed via a double walk process, $6 + h\nu \rightarrow \text{BC-6} \rightarrow \text{BC-4} \rightarrow \text{BC-2} \rightarrow 2$ and/or $6 + h\nu \rightarrow \text{BC-6} \rightarrow \text{BC-1} \rightarrow \text{BC-2} \rightarrow 2$. This latter pathway must account for at least a portion of the transposition pathway since the formation of 2-phenylthiazole (**1**) in this reaction implicates the existence of **BC-1** on the transposition pathway.

The observed distribution of deuterium in the phototransposition products of 2-deuterio-5-phenylthiazole (**2-D-3**) is also consistent with the electrocyclic ring closure-sulfur migration

(19) Although preliminary AM1 calculations do not reveal any substantial differences in the ground-state energies of the members of the tetrad, these calculations do support the suggestion that **BC-2** is the most stable bicyclic intermediate.

(20) Kellogg, R. R. *Tetrahedron Lett.* 1972, 1429–1423.

(21) Shiner, V. J., Jr.; Buddenbaum, W. E.; Murr, B. L.; Lamaty, G. J. *Am. Chem. Soc.* 1968, 90, 418–426.

(22) Harris, J. M.; Hall, R. E.; Schleyer, P. v. R., *J. Am. Chem. Soc.* 1971, 93, 2551–2553.

Scheme 5

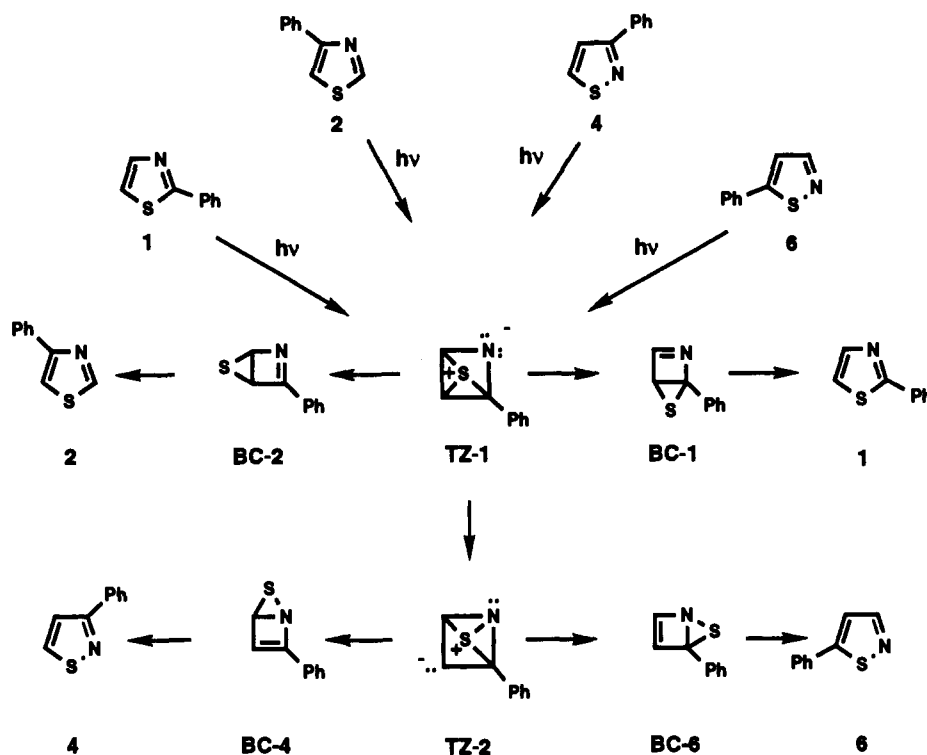

Scheme 6

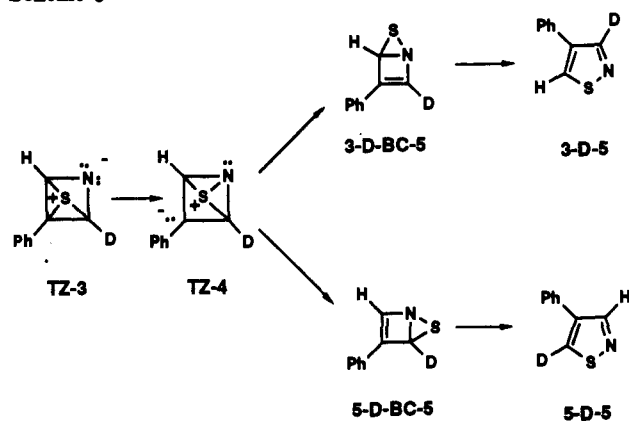

mechanism. Thus, as shown in Scheme 3, 5-deuterio-4-phenylthiazole (5-D-5) would be expected to be the predominate phototransposition product since it is formed *via* a single sulfur walk pathway, $2\text{-D-}3 + h\nu \rightarrow 2\text{-D-BC-}3 \rightarrow 5\text{-D-BC-}5 \rightarrow 5\text{-D-}5$, whereas 3-deuterio-4-phenylthiazole (3-D-5) is the product of a double-walk pathway, $2\text{-D-}3 + h\nu \rightarrow 2\text{-D-BC-}3 \rightarrow 5\text{-D-BC-}5 \rightarrow 3\text{-D-BC-}5 \rightarrow 3\text{-D-}5$ and/or $2\text{-D-}3 + h\nu \rightarrow 2\text{-D-BC-}3 \rightarrow 4\text{-D-BC-}3 \rightarrow 3\text{-D-BC-}5 \rightarrow 3\text{-D-}5$. Since 2-D-BC-3 would be expected to isomerize to the more stable 5-D-BC-5 more rapidly than to the isoenergetic 4-D-BC-3, the former pathway would be expected to be the major route for the formation of 3-D-5. The observation of 4-D-3 as a photoproduct in this reaction does, however, indicate the intermediacy of some 4-D-BC-3, which would be expected to partition between rearomatization to 4-D-3 and isomerization to 3-D-BC-5.

In principle, 5-D-BC-5, the suggested precursor of 3-D-BC-5 in the above pathway, should also be accessible by direct excitation of 5-D-5. The above pathway thus suggests that 5-D-5 should phototranspose to 3-D-5. Experimentally, however, although 5-D-5 is observed to undergo rapid photoreaction, NMR analysis of the unconverted reactant reveals no evidence for the formation of 3-D-5. While these results appear to be inconsistent with the

electrocyclic ring closure-sulfur migration mechanism, it is plausible that while 5-D-BC-5 is accessible from 2-D-BC-3 by sigmatropic migration of sulfur, it is not formed by direct excitation of 5-D-5. Thus, the much greater reaction efficiency observed for 4-phenylthiazole (5) indicates that excited 5 reacts more rapidly by a nonphototransposition pathway than by electrocyclic ring closure.

Photodeuteration Studies. The tricyclic zwitterion mechanism was originally proposed by Maeda and Kojima to explain the deuterium incorporation observed when the phototransposition reactions were carried out in benzene saturated with D_2O .^{9d} When each of the six isomers was irradiated under these conditions and the products analyzed by NMR and/or mass spectroscopy, Maeda and Kojima reported that only 3-phenylthiazole (4) was formed with deuterium incorporation. In our laboratory, in addition to the formation of 4-deuterio-3-phenylthiazole (4-D-4), we have also observed that 4-phenylthiazole (2) is formed with deuterium incorporation at position 2. Maeda and Kojima also reported that none of the recovered reactants had undergone deuterium incorporation when irradiated in benzene- D_2O . In our laboratory, however, we observe that 4-phenylthiazole (2) undergoes rapid photodeuteration at C-2 when irradiated under these conditions. Thus, although before irradiation the mass spectrum of 4-phenylthiazole (2) shows an *m/e* 161:162 ratio of 1:0.11, after 2 h of irradiation, the ratio had changed to 1:0.77, indicating rapid deuterium incorporation. After this irradiation time, 3-phenylthiazole (4), the phototransposition product, could not yet be detected by GLC analysis. Furthermore, after 13 h of irradiation the 161:162 ratio had changed to 1:3.7, indicating that approximately 80% deuterium incorporation had occurred. ^1H NMR analysis of the recovered 4-phenylthiazole (2) revealed that the one-proton doublet ($J = 2.0$ Hz) at δ 7.45 due to the C-5 proton had collapsed to a one-proton singlet, while the one-proton doublet at δ 8.80 due to the C-2 proton was greatly diminished in area, integrating to approximately 0.15 proton, consistent with approximately 85% deuterium incorporation at position 2. This photodeuteration is so rapid that we conclude that the 2-deuterio-4-phenylthiazole (2-D-2) observed among the phototransposition products is most

likely derived by secondary photodeuteration of **2** rather than by deuterium incorporation by an intermediate leading to the formation of **2**. This was confirmed by irradiating either 2-phenylthiazole (**1**) or 5-phenylisothiazole (**6**) in benzene- D_2O through a Pyrex filter. Although both **1** and **6** have measurable absorption beyond the Pyrex cutoff, 4-phenylthiazole (**2**) has no appreciable absorption at these longer wavelengths. After irradiation of **2** or **6** under these conditions, mass spectral analysis confirmed that the 4-phenylthiazole (**2**) photoproduct had been formed without deuterium incorporation.

Careful monitoring of the mass spectrum of 3-phenylisothiazole (**4**) during photolysis in benzene- D_2O revealed that this isomer also undergoes photodeuteration but at a much slower rate. Thus, before irradiation the mass spectrum of **4** exhibited an m/e 161:162 ratio of 1:0.11. After 12 h of irradiation this ratio increased to 1:0.14, while after 41 and 65 h of irradiation the 161:162 ratio continued to increase to 1:0.17 and 1:0.20, respectively, confirming that the signal at m/e 162 was increasing relative to the m/e 161 peak, consistent with deuterium incorporation. As required by this conclusion, whereas the 1H NMR spectrum of the recovered 3-phenylisothiazole (**4**) indicated no change in the multiplicity of the one-proton doublet ($J = 5.0$ Hz) for the C-4 proton at δ 7.55, the signal at δ 8.65 due to the C-5 proton was changed from a doublet ($J = 5.0$ Hz) before irradiation to a doublet and a singlet after irradiation for the undeuterated and monodeuterated compounds, respectively. This confirms that photodeuteration has occurred and also shows that the deuterium has been incorporated at position 4 of the isothiazole ring. This conclusion was further supported by the mass spectral changes observed upon irradiation of 5-deuterio-3-phenylisothiazole (**5-D-4**) in benzene saturated with either D_2O or H_2O . The mass spectrum of **5-D-4** exhibited an m/e 162:163 ratio of 1:0.11. After 12 h of irradiation in benzene- D_2O , this ratio increased to 1:0.14. Thus, after 12 h of irradiation the extent of photodeuteration of **5-D-4** was the same as the extent of photodeuteration of **4**. This confirms that deuterium incorporation occurs at position 4. Finally, after 12 h of irradiation of **5-D-4** in benzene saturated with H_2O the m/e 162:163 ratio remained 1:0.11, indicating no loss of the C-5 deuterium, providing conclusive evidence that exchange occurs at position 4 in 3-phenylisothiazole (**4**). It is interesting to note that although no loss of deuterium is observed in **5-D-5**, the 4-phenylthiazole phototransposition product contains progressively less deuterium. Thus, after 2 h of irradiation the mass spectrum of the photoproduct exhibited an m/e 162:161 ratio of 1:0.12, while after 12 h of irradiation the ratio was 1:0.23. This is consistent with the initially formed **2-D-2** undergoing secondary photoexchange to yield **2**.

In their earlier work Maeda and Kojima reported that 4-phenylthiazole (**2**) undergoes phototransposition in benzene- D_2O to yield 4-deuterio-3-phenylisothiazole (**4-D-4**).^{9d} Their results are inexplicable in view of our observation that 4-phenylthiazole (**2**) undergoes photodeuteration to yield **2-D-2** much more rapidly than it undergoes phototransposition to 3-phenylisothiazole (**4**) and that **2-D-2** is known to phototranspose to 5-deuterio-3-phenylisothiazole (**5-D-3**).

We observe that whereas 13 h of irradiation of 4-phenylthiazole (**2**) in benzene- D_2O was accompanied by 85% deuterium incorporation into the reactant, the mass spectrum of the 3-phenylisothiazole photoproduct exhibited an m/e ratio of 1:1.6 with no significant signal at m/e 163. This shows that approximately 60% of the photoproduct is formed as monodeuterated-3-phenylisothiazole and that this deuterium incorporation must arise *via* initial photodeuteration of 4-phenylthiazole, and thus the deuterium must be located at position 5 of 3-phenylisothiazole. After a total of 48 h of irradiation, mass spectral analysis of the 3-phenylisothiazole revealed a significant m/e 163 signal due to the formation of dideuterio-3-phenylisothiazole formed by secondary photodeuteration of the initially formed **5-D-4**.

These results clearly show that during the phototransposition of 4-phenylthiazole (**2**) to 3-phenylisothiazole (**4**) in benzene- D_2O , the deuterium observed in the photoproduct arises by initial rapid photodeuteration of the reactant and subsequent slow photodeuteration of the product but not by deuterium incorporation into any intermediate on the 4-phenylthiazole (**2**) \rightarrow 3-phenylisothiazole (**4**) transposition coordinate.

The formation of 4-deuterio-3-phenylisothiazole (**4-D-4**) upon irradiation of either 2-phenylthiazole (**1**) or 5-phenylisothiazole (**6**) in benzene- D_2O is mechanistically quite different. In these cases although after 12 h of irradiation of **1** or **5** in benzene- D_2O mass spectral analysis did not indicate any significant deuterium incorporation into either reactant, the mass spectrum of the 3-phenylisothiazole photoproduct formed from **1** or **5** showed m/e 161:162 ratios of 1:0.26 or 1:0.52, respectively. Thus, in either case the deuterium incorporation does not arise *via* initial deuterium incorporation into either reactant. Furthermore, the extent of deuterium incorporation is much too large to arise only from the secondary photodeuteration of 3-phenylisothiazole (after 12 h of irradiation of 3-phenylisothiazole in benzene- D_2O the m/e 161:162 ratio was 1:0.14). In addition, when **1** or **6** was irradiated in benzene- D_2O through a Pyrex filter, 3-phenylisothiazole (**4**) was still formed with deuterium incorporation. Since **4** has no measurable absorption beyond the Pyrex cutoff, secondary photodeuteration of **4** is precluded. Accordingly, we conclude that most of the 4-deuterio-3-phenylisothiazole (**4-D-4**) must have been formed by incorporation of deuterium by an intermediate on the 2-phenylthiazole (**1**) and 5-phenylisothiazole (**6**) \rightarrow 3-phenylisothiazole (**4**) reaction pathways.

These results show that within the tetrad the intermediate which incorporates deuterium is on both the 2-phenylthiazole (**1**) and 5-phenylisothiazole (**6**) \rightarrow 3-phenylisothiazole (**4**) pathway but is not on the 4-phenylthiazole (**2**) \rightarrow 3-phenylisothiazole (**4**) pathway. In order to rationalize these results, we postulate that bicyclic intermediate **BC-6** undergoes deuteration with simultaneous sulfur walk to yield (**4D-BC-6**)⁺. Deuteration is thus

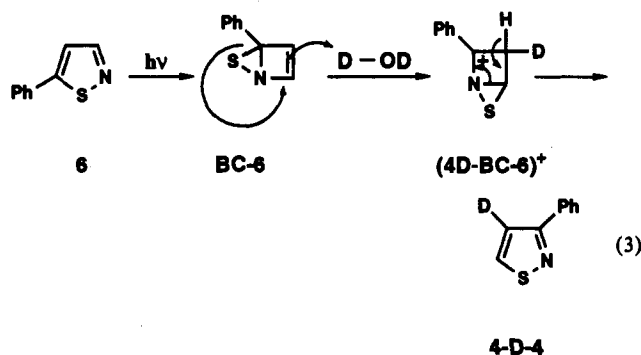

assisted by the sulfur walk and by the stability of the resulting carbocation due to delocalization of the positive charge throughout the phenyl ring and by overlap from the lone pair of electrons on the adjacent nitrogen. This accounts for the lack of photodeuteration of **6** and for the greater deuterium incorporation in 3-phenylisothiazole (**4**) formed from 5-phenylisothiazole (**6**) than from 2-phenylthiazole (**1**). From **6**, all molecules of **4** must arise *via* **BC-6**, i.e., $6 + h\nu \rightarrow \text{BC-6} \rightarrow \text{BC-4} \rightarrow 4$. From 2-phenylthiazole (**1**), however, 3-phenylisothiazole (**4**) can be formed by the pathway $1 + h\nu \rightarrow \text{BC-1} \rightarrow \text{BC-6} \rightarrow \text{BC-4} \rightarrow 4$ with deuterium incorporation or by the pathway $1 + h\nu \rightarrow \text{BC-1} \rightarrow \text{BC-2} \rightarrow \text{BC-4} \rightarrow 4$ without deuterium incorporation.

P₄ Pathway. As shown in Scheme 1, in addition to undergoing P₅, P₆, and P₇ phototranspositions leading to the other three members of the tetrad, 5-phenylisothiazole (**6**) was also observed to phototranspose *via* a P₄ pathway to provide 5-phenylthiazole (**3**) in very low yield. In this reaction product identification allows distinction between the P₄ pathway and the P₅, P₆, P₇ sulfur walk

Scheme 7

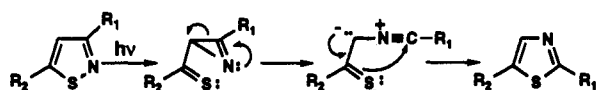

mechanisms. In the case of 3-phenylisothiazole (4), although the P₆ single sulfur walk pathway leads to a unique product, 4-phenylthiazole (2), both the P₄ and the double sulfur walk P₇ pathways lead coincidentally to the same product, 2-phenylthiazole (1). Whereas mass spectral analysis confirms that 5-deuterio-3-phenylisothiazole (5-D-4) phototransposes to 2-deuterio-4-phenylthiazole (2-D-2) as demanded by the P₆ permutation pathway, deuterated-2-phenylthiazole is formed in insufficient quantities to allow determination of the position of the deuterium. The conversion of 3-phenylisothiazole (4) to 2-phenylthiazole (1) via the P₇ pathway is unlikely, however, since it would require a pathway involving 4 + *hν* → BC-4 → BC-2 → BC-1 → 1. 4-Phenylthiazole (2), however, phototransposes only to 3-phenylisothiazole (4) and not to 2-phenylthiazole (1). This reveals that BC-2 partitions only between 2 and BC-4 and not to the significantly less stable species BC-1. The absence of the formation of 5-phenylisothiazole (6) from 3-phenylisothiazole (4) makes walk in the opposite direction, i.e., 4 + *hν* → BC-4 → BC-6 → BC-1 → 1, also unlikely. In view of these arguments, it is more likely that 2-phenylthiazole (1) is formed from 3-phenylisothiazole (4) via the P₄ permutation pathway.

The 2,3-interchange demanded by the P₄ phototransposition of isothiazole 4 or 6 to thiazole 1 or 3 can be rationalized by the ring contraction–ring expansion mechanism (Scheme 7) and the intermediacy of thioacylazirine 7 or 9. Previous workers have demonstrated the involvement of acylazirines in the analogous isoxazole → oxazole P₄ phototransposition,²³ and 3-phenyl-2-(*N*-phenylimino)-2*H*-azirine (11) has been shown to undergo photorearrangement to 1,2-diphenylimidazole (13),²⁴ presumably via the nitrile ylide intermediate 12.²⁵ Since the P₄ permutation

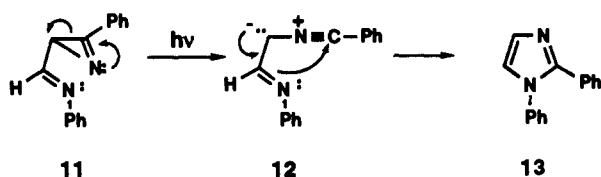

has been observed as a major transposition pathway in other five-membered heterocycles containing two adjacent heterocycles, it is somewhat surprising that it is such a minor pathway for phenylisothiazoles in benzene solvent. This pathway has been studied in greater detail, and those results will be reported elsewhere.

Direct Photodeuteration. Although the mechanism for the rapid direct photodeuteration of 4-phenylthiazole (2) was not investigated, lack of deuterium incorporation in 2 during phototransposition of 3-phenylisothiazole (4) in benzene–D₂O pre-

(23) (a) Kurtz, D. W.; Schechter, H. *J. Chem. Soc., Chem. Commun.* 1966, 686. (b) Ullman, E. F.; Singh, B. *J. Am. Chem. Soc.* 1966, 88, 1844. *Ibid.* 1967, 89, 6911. (c) Singh, A.; Zweig, A.; Gallivan, J. B. *J. Am. Chem. Soc.* 1972, 94, 1199. (d) Nishiwaki, T.; Nakano, A.; Matsuoka, J. *J. Chem. Soc. C* 1970, 1825. (e) Nishiwaki, T.; Fujiyama, F. *J. Chem. Soc., Perkin Trans. 1* 1972, 1456. (f) Wamhoff, H. *Chem. Ber.* 1972, 105, 748. (g) Good, R. H.; Jones, G. *J. Chem. Soc. C* 1971, 196. (h) Goth, H.; Gagneux, A. R.; Eugster, C. H.; Schmid, H. *Helv. Chim. Acta* 1967, 50, 137. (i) Padwa, A.; Chen, E.; Kua, A. *J. Am. Chem. Soc.* 1975, 97, 6484–6491. (j) Kietliker, K.; Gilgen, P.; Helmgartner, H.; Schmid, H. *Helv. Chim. Acta* 1976, 59, 2074–2099.

(24) Padwa, A.; Smolanoff, J.; Tremper, A. *Tetrahedron Lett.* 1974, 29–32; *J. Am. Chem. Soc.* 1975, 97, 4682–4691.

(25) Padwa, A. *Acc. Chem. Res.* 1976, 9, 371–378.

Scheme 8

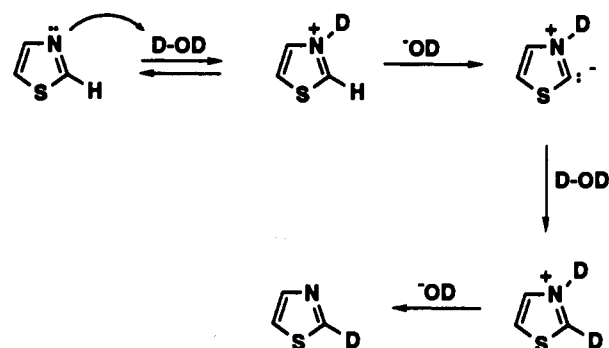

cludes the involvement of BC-2 in this deuteration. In the ground state, below pH 11, thiazole undergoes regiospecific deuterium exchange at C-2 via the protonation/deprotonation mechanism shown in Scheme 8.²⁶

Although 4-phenylthiazole (2) is not sufficiently basic to undergo N-deuteration in benzene–D₂O, it is plausible that the excited singlet of 2 is significantly more basic than the ground state molecule. If this is the case, 2*(S₁) could undergo N-deuteration and regiospecific H/D exchange according to the mechanism shown in Scheme 8.

Conclusion

Phenylthiazoles 1–3 and phenylisothiazoles 4–6 undergo phototransposition in benzene solvent mainly by P₅, P₆, and P₇ permutation pathways. Phenylisothiazoles 5 and 6 also transpose via a P₄ permutation process to yield phenylthiazoles 2 and 3 in less than 1% yield. In benzene saturated with D₂O, 2-phenylthiazole (1) and 5-phenylisothiazole (6) each phototranspose to yield 4-deuterio-3-phenylisothiazole (4-D-4) and 4-phenylthiazole (2) without deuterium incorporation. Irradiation of 4-phenylthiazole (2) under these conditions results in rapid photodeuteration to yield 2-deuterio-4-phenylthiazole (2-D-2), which subsequently phototransposes to 5-deuterio-3-phenylisothiazole (5-D-3). Upon continued irradiation 5-D-3 undergoes slow photodeuteration to form 4,5-dideuterio-3-phenylisothiazole (4,5-D₂-3).

Although tricyclic zwitterion intermediates have previously been evoked to explain the phototransposition and photodeuteration reactions, the observed ratios of the phototransposition products from 2-phenylthiazole (1) and 5-phenylisothiazole (6) and the deuterium scrambling observed upon phototransposition of 2-deuterio-5-phenylthiazole (2-D-3) are not consistent with this mechanistic interpretation. Furthermore, whereas the photodeuteration observed upon irradiation of these compounds in benzene–D₂O was formerly thought to demand tricyclic intermediates, a reinvestigation of these reactions has now shown that they are also inconsistent with the tricyclic zwitterion mechanism. We conclude, therefore, that such species are not intermediates in either the phototransposition or photodeuteration reactions.

These experimental results can be rationalized by a mechanism involving initial electrocyclic ring closure and sigmatropic shift of the sulfur around the four sides of the azetine ring. Rearomatization of each bicyclic intermediate thus allows sulfur to insert into each position in the carbon–nitrogen sequence. As a consequence, these compounds divide into a tetrad in which isomers 1, 2, 4, and 6 interconvert mainly via P₅, P₆, and P₇ pathways and a dyad of two compounds in which 3 phototransposes to 5 via P₅ and P₇ pathways. Within the tetrad, BC-6, the bicyclic intermediate derived from 5-phenylisothiazole (6), is postulated to undergo deuteration with simultaneous sigmatropic shift of

(26) Coburn, R. A.; Landesberg, J. M.; Kemp, D. S.; Olofson, R. A. *Tetrahedron* 1970, 26, 685–692.

sulfur when the reaction is carried out in benzene-D₂O. This mechanistic view provides one coherent interpretation for the observed phototransposition and photodeuteration reactions.

Experimental Section

General Procedures. ¹H and ¹³C NMR spectra were recorded at 200 and 50.3 MHz on a Bruker FT-NMR system. ¹H and ¹³C chemical shifts were measured relative to internal Me₄Si and CHCl₃, respectively. Infrared spectra were recorded on a PE-1620 FT spectrometer. GLC was performed on a PE-8500 FID instrument equipped with a 30 m × 0.25 μ Supelcowax 10 bonded phase. Mass spectra were recorded with an HP 5970B mass selective detector interfaced to an HP 5880 capillary gas chromatograph. Flash column chromatography was carried out on silica gel, 40 μ average particle size (J.T. Baker, Inc.). Preparative-layer chromatography was carried out on 20 × 20 cm glass plates coated with 2 mm of Kieselgel 60 F₂₅₄ (Merck).

Synthesis of Phenylthiazoles and Phenylisothiazoles. Bromoacetaldehyde diethyl acetal, thio benzamide, and thiourea were available from Aldrich Chemical Co.

2-Phenylthiazole (1). Bromoacetaldehyde diethyl acetal (11.8 g, 60.0 mmol) and dry tetrahydrofuran (50 mL) was added dropwise over 1 h to a stirred mixture of thio benzamide (8.23 g, 60.0 mmol) in dry tetrahydrofuran (100 mL) while the temperature was maintained between 70 and 80 °C. The resulting mixture was stirred at this temperature for 8 h, cooled to room temperature, made basic with 50% aqueous sodium hydroxide, and steam distilled. The distillate (500 mL) was extracted with ether (5 × 100 mL). The ethereal extract was dried (Na₂SO₄) and concentrated by rotary evaporation. The yellow residual oil (5.71 g) was subjected to silica gel (40 g) flash column chromatography. The column (65 cm long × 1.5-cm diameter) was eluted with hexane-dichloromethane (3:7), and 10-mL fractions were collected. The fractions which showed only the desired product by TLC were combined and concentrated to give a colorless oil, which was distilled (Kugelrohr) to give 2-phenylthiazole (1) as a colorless oil: bp (oven temperature) 80 °C (0.2 Torr) (lit.²⁷ bp 135 °C at 18 Torr); 4.0 g (24.8 mmol, 41.3% yield); ¹H NMR (CDCl₃) δ 7.20–7.55 (m, 4H), 7.80–8.10 (m, 3H); ¹³C NMR (CDCl₃) δ 168.3 (C-2), 143.6 (C-4), 130.0 (C-5), 133.5 (Ph, C-1'), 128.9 (Ph, C-2', 2''), 126.5 (Ph, C-3', 3''), 118.8 (Ph, C-4'); IR (neat) 3064, 1600, 1506, 1480, 1447, 1416, 1320, 1248, 1142, 1055, 1000, 971, 874, 762 cm⁻¹; MS *m/e* (%) 161 (44), 58 (100).

4-Phenylthiazole (2). Sodium nitrite (6.20 g, 0.090 mol) was added over a period of 45 min to a stirred solution of 2-amino-4-phenylthiazole²⁸ (10.0 g, 0.057 mol) dissolved in concentrated sulfuric acid (100 mL) which was maintained at 0 °C. The resulting mixture was added in small portions during a period of 1 h to a stirred solution of hypophosphorous acid (30%, 150 mL) containing Cu₂O (0.20 g) while maintaining the temperature at -5 °C. The solution was allowed to warm to room temperature and stirred until gas evolution ceased. It was then made basic with 50% aqueous sodium hydroxide and steam distilled. The distillate (500 mL) was extracted with ether (3 × 100 mL), and the ethereal extract was dried (Na₂SO₄) and evaporated. The residue was sublimed (40 °C, 0.5 Torr) to give 4-phenylthiazole (2) as white crystals: mp 55–56 °C (lit.²⁷ mp 52 °C); 1.83 g (11.0 mmol, 19.3% yield); ¹H NMR (CDCl₃) δ 7.25–7.40 (m, 3H), 7.45 (d, 1H, *J* = 2.0 Hz), 7.80–8.10 (m, 2H), 8.80 (d, 1H, *J* = 2.0 Hz); ¹³C NMR (CDCl₃) δ 152.8 (C-2), 156.4 (C-4), 128.2 (C-5), 134.2 (Ph, C-1') 128.8 (Ph, C-2', 2''), 126.4 (Ph, C-3', 3''), 112.5 (Ph, C-4'); IR (KBr) 1474, 1410, 1069, 902, 884, 818, 770 cm⁻¹; MS *m/e* (%) 161 (92), 134 (100).

5-Phenylthiazole (3). 1,1-Dimethoxy-2-bromo-2-phenylethane²⁹ (33.6 g, 0.14 mol), thiourea (20.2 g, 0.26 mol), and aqueous HBr (48%, 0.30 mL) were heated at 100 °C for 2 h with continuous removal of methanol by distillation. The resulting mixture was allowed to cool to room temperature, acidified with aqueous HCl (6M, 60 mL), and extracted with chloroform (60 mL). The chloroform extract was discarded, and the aqueous layer was brought to pH 9 by the addition of concentrated aqueous ammonia. The yellow precipitate was collected by suction filtration, washed with water, and dried under vacuum to yield 2-amino-5-phenylthiazole (22.1 g, 0.12 mol, 89% yield), mp 180–182 °C (lit.³⁰ mp 207.5–208.5 °C).

Sodium nitrite (6.9 g, 0.10 mol) was added slowly in small portions with stirring to concentrated sulfuric acid (20 mL) at 0 °C. 2-Amino-5-phenylthiazole (10.4 g, 0.059 mol) was then added in small portions over 60 min while maintaining the temperature at 0 °C. The reaction mixture was stirred at 0 °C for 1 h and added at 0 °C during a period of 30 min to a stirred suspension of Cu₂O (0.30 g) and hypophosphorous acid (30%, 130 mL) at -5 °C. The reaction mixture was allowed to warm to room temperature. After gas evolution ceased, the solution was brought to pH 9 by the addition of aqueous sodium hydroxide (25%) and steam distilled. The distillate (500 mL) was extracted with ether (5 × 100 mL). The ethereal extract was dried (Na₂SO₄) and concentrated by rotary evaporation. Distillation (Kugelrohr) of the residual solid gave 5-phenylthiazole (3), which solidified to a white solid: bp (oven temperature) 80 °C (0.2 Torr), mp 44–45 °C (lit.²⁷ mp 45 °C); 1.88 g (0.012 mol; 20.3% yield); ¹H NMR (CDCl₃) δ 7.20–7.65 (m, 5H), 8.05 (s, 1H), 8.70 (s, 1H), ¹³C NMR (CDCl₃) δ 152.0 (C-2), 138.9 (C-4), 139.3 (C-5), 131.0 (Ph, C-1') 129.1 (Ph, C-2', 2''), 126.9 (Ph, C-3', 3''), 128.6 (Ph, C-4'); IR (KBr) 3048, 1447, 1389, 1318, 1075, 908, 860, 830, 759, 688 cm⁻¹; MS *m/e* (%) 161 (91), 134 (100).

3-Phenylisothiazole (4). 3-Amino-3-phenyl-2-propenenitrile³¹ (15.0 g, 10.4 mmol) dissolved in 2-propanol (15 mL) was added to diphenylphosphinodithioic acid³² (6.93 g, 27.7 mmol), and the resulting mixture was stirred at 40 °C for 20 h. The resulting mixture was cooled to room temperature, 2-propanol (60 mL) was added, and the pale green diphenylphosphinodithioic acid thioanhydride was collected by suction filtration. The filtrate was cooled to -10 °C, and an additional small amount of this solid was collected by suction filtration. The filtrate was added to dichloromethane (300 mL), and the resulting solution was washed with water (3 × 100 mL), saturated aqueous sodium bicarbonate (1 × 100 mL), dried (Na₂SO₄), and evaporated to dryness by rotary evaporation. The resulting red semisolid (1.5 g) was recrystallized from benzene to yield 3-phenyl-3-iminothiopropanamide as yellow crystals: mp 171–173 °C (lit.³³ mp 169–171 °C); 0.48 g (2.70 mmol, 26.0% yield); ¹H NMR (DMSO-*d*₆) δ 5.42 (s, 2H), 7.42–7.56 (m, 5H), 7.79 (br s, 2H), 8.12 (br s, 1H); IR (KBr) 3420, 3339, 3274, 3173, 1604, 1544, 1492, 1470, 1379, 991, 769, 696, 538, 479 cm⁻¹.

3-Phenyl-3-iminothiopropanamide (2.70, 15.2 mmol) was treated with iodine in ethanol according to the procedure of Goerdeler and Pohland³⁴ to give 5-amino-3-phenylisothiazole as a yellow solid: mp 154–158 °C (lit.³⁴ mp 163 °C); 2.60 g (14.8 mmol, 97.4% yield); ¹H NMR (DMSO-*d*₆) δ 6.61 (br s, 2H), 6.71–6.74 (m, 1H), 7.31–7.45 (m, 3H), 7.79–8.84 (m, 2H); IR (KBr) 3427, 3266, 3167, 1611, 1527, 1460, 1413, 1389, 908, 798, 771, 692 cm⁻¹.

5-Amino-3-phenylisothiazole (2.60 g, 14.8 mmol) was diazotized and reduced according to the literature procedure³⁵ to yield 3-phenylisothiazole (4) as a pale yellow oil: bp (Kugelrohr oven temperature) 130 °C (2.0 Torr) (lit.³⁵ bp 65 °C at 0.2 Torr) 0.90 g (5.59 mmol, 37.7% yield); ¹H NMR (CDCl₃) δ 7.50–7.55 (m, 3H), 7.55 (d, 1H, *J* = 5.0 Hz), 7.85–8.05 (m, 2H), 8.65 (d, 1H, *J* = 5.0 Hz); ¹³C NMR (CDCl₃) δ 167.7 (C-3), 129.2 (C-4), 148.9 (C-5), 134.6 (Ph, C-1'), 128.8 (Ph, C-2', 2''), 126.9 (Ph, C-3', 3''), 121.2 (Ph, C-4'); IR (neat) 3066, 3034, 1059, 1483, 1451, 1379, 1306, 1085, 1068, 1026, 867, 836, 780 cm⁻¹; MS *m/e* (%) 161 (100), 58 (41), 53 (30).

4-Phenylisothiazole (5). 3-Chloro-2-phenylpropenal³⁶ (10.0 g, 0.060 mol) and ammonium thiocyanate (10 g, 0.13 mol) were refluxed in acetone (100 mL) for 6 h (CAUTION: HCN evolution).³⁷ The resulting mixture was allowed to cool, brought to pH 9 with 50% aqueous NaOH, and steam distilled. The distillate (2.0 L) was extracted with ether (3 × 150 mL). The ethereal extract was dried (Na₂SO₄) and concentrated by rotary evaporation. The yellow residual oil (8.0 g) was subjected to silica gel (100 g) flash column chromatography. The column (30 cm long × 2.7-cm diameter) was eluted with dichloromethane (300 mL), and 10-mL fractions were collected. The fractions which showed only the desired product by TLC were combined and concentrated to give a white solid, which was sublimed (40 °C, 0.2 Torr) to give 4-phenylisothiazole (5) as

(31) Kuthan, J.; Jehlicka, V.; Hakr, E. *Collect. Czech. Chem. Commun.* 1967, 32, 4309–4318.

(32) Benner, S. A. *Tetrahedron Lett.* 1981, 22, 1851–1854.

(33) Naito, T.; Nakagawa, S.; Tokahashi, K. *Chem. Pharm. Bull.* 1968, 16, 148–159.

(34) Goerdeler, J.; Pohland, H. W. *Chem. Ber.* 1961, 94, 2950–2959.

(35) Boeringer, M.; Priejs, B.; Erlenmeyer, H. *Helv. Chim. Acta* 1966, 49, 2466–2469.

(36) Arnold, Z.; Zemlicka, J. *Proc. Chem. Soc.* 1958, 227.

(37) Muehlstaedt, M.; Braemar, R.; Schulze, B. *J. Prakt. Chem.* 1976, 318, 507–514.

(27) Vernin, G.; Aune, J. P.; Dou, H. J. M.; Metzger, J. *Bull. Soc. Chim. Fr.* 1967, 4523–4533.

(28) Dodson, R. M.; King, L. C. *J. Am. Chem. Soc.* 1945, 67, 2242–2243.

(29) Bedoukian, P. Z. *J. Am. Chem. Soc.* 1944, 66, 1325–1327.

(30) Hurd, C. D.; Wehrmeister, H. L. *J. Am. Chem. Soc.* 1949, 71, 4007–4010.

white crystals: mp 36–37 °C (lit.³⁸ mp 35–36 °C); 2.0 g (0.012 mol, 21% yield); ¹H NMR (CDCl₃) δ 7.80–7.55 (m, 5H), 8.65 (s, 1H), 8.75 (s, 1H); ¹³C NMR (CDCl₃) δ 156.0 (C-3), 139.9 (C-4), 142.6 (C-5), 132.5 (Ph, C-1'), 129.1 (Ph, C-2', 2'), 126.9 (Ph, C-3', 3'), 128.0 (Ph, C-4'); IR (KBr) 3097, 1062, 1533, 1486, 1450, 1349, 1235, 1194, 1074, 1048, 912, 858, 757 cm⁻¹; MS *m/e* (%) 161 (100), 134 (57).

5-Phenylisothiazole (6). 3-Chloro-3-phenylpropenal³⁹ (18.0 g, 0.11 mol) and ammonium thiocyanate (22.8 g, 0.30 mol) were refluxed in acetone (150 mL) and worked up as above for 4-phenylisothiazole (5). The red residual oil (12.4 g) was subjected to silica gel (100 g) flash column chromatography as above to give a yellow solid, which was sublimed (40 °C, 0.5 Torr) to give 5-phenylisothiazole (6) as white crystals: mp 47–48 °C (lit.³⁸ mp 46–47 °C); 2.5 g (0.016 mol, 15% yield); ¹H NMR (CDCl₃) δ 7.40 (d, 1H, *J* = 2.0 Hz), 7.25–7.70 (m, 5H), 8.45 (d, 1H, *J* = 2.0 Hz); ¹³C NMR (CDCl₃) δ 158.2 (C-3), 129.6 (C-4), 167.4 (C-5), 130.8 (Ph, C-1'), 129.2 (Ph, C-2', 2'), 126.7 (Ph, C-3', 3'), 119.8 (Ph, C-4'); IR (KBr) 3091, 1523, 1484, 1446, 1418, 1300, 1240, 1098, 1076, 911, 822, 757 cm⁻¹; MS *m/e* (%) 161 (100), 134 (56).

2-Deuterio-5-phenylthiazole (2-D-3). Sodium metal (0.29 g, 12.6 mmol) was added to CH₃OD (30 mL). After the reaction was complete, 5-phenylthiazole (1.0 g, 6.2 mmol) was added and the flask was tightly closed and allowed to stand at room temperature in the dark for 5 days. The resulting solution was added to aqueous HCl (5 M, 50 mL), and the mixture was extracted with dichloromethane (3 × 100 mL). The extract was dried (Na₂SO₄) and concentrated to yield a white solid that was sublimed (40 °C, 0.1 Torr) to give 2-deuterio-5-phenylthiazole (2-D-3) as white crystals: mp 44–45 °C; 0.91 g (5.6 mmol, 90% yield); ¹H NMR (CDCl₃) δ 7.65–7.20 (m, 5H), 8.05 (s, 1H); MS *m/e* (%) 162 (100), 135 (36.5), 134 (98.3).

5-Deuterio-3-Phenylisothiazole (5-D-4). 3-Phenylisothiazole (0.25 g, 1.44 mmol) was allowed to react with CH₃OD (10 mL) containing sodium metal (0.13 g, 5.4 mmol) and worked up as above to yield a colorless oil (0.25 g) which was distilled (Kugelrohr) to give 5-deuterio-3-phenylisothiazole (5-D-4) as a colorless oil: bp (oven temperature) 120 °C (1.5 Torr); 0.22 g (1.36 mmol, 88% yield); ¹H NMR (CDCl₃) δ 7.35–7.50 (m, 3H), 7.55 (s, 1H), 7.85–8.05 (2H, m); MS *m/e* (%) 162 (100), 135 (30.7).

5-Deuterio-4-Phenylisothiazole (5-D-5). 4-Phenylisothiazole (0.98 g, 6.09 mmol) was allowed to react with CH₃OD (30 mL) containing sodium metal (0.219 g, 8.7 mmol) and worked up as above to yield a semisolid (0.95 g) that was sublimed (40 °C, 0.1 Torr) to give 5-deuterio-4-phenylisothiazole (5-D-5) as white crystals: 0.90 g (5.5 mmol, 90% yield); ¹H NMR (CDCl₃) 7.35–7.80 (m, 5H), 8.65 (s, 1H); MS *m/e* (%) 162 (100), 135 (44).

Irradiation and Analysis Procedures. To monitor phenylisothiazole and phenylthiazole phototransposition reactions on an analytical scale, a solution of the appropriate reactant (10.0 mL, 2.0 × 10⁻² M) in benzene was placed in a quartz tube (1.45-cm i.d. × 13 cm long) sealed with a rubber septum and purged with argon for 30 min prior to irradiation. The tubes were irradiated at 254 nm in a Rayonet photochemical reactor containing 8 low-pressure Hg lamps for 1, 3, 5, and 6 or 16 lamps for 2 and 4. Preparative-scale reactions were carried out by irradiating an argon-purged solution of the appropriate reactant (80 mL, 2.0 × 10⁻² M) in benzene in a quartz tube (2.2-cm i.d. × 27 cm long). Irradiations of 1 and 6 at longer wavelengths were carried out in Pyrex tubes with a Hanovia 450-W Hg arc in a Pyrex well.

The formation of phototransposition products was monitored by removing aliquots for GLC analysis every 10 min for 5 and 6, every 30 min for 1, 3, and 4, or every 24 h for 2. Major products were detected by GLC analysis at 190 °C without concentration, while minor products were detected by concentrating the irradiated solution (25 to 1) before

GLC analysis. The retentions of all products at 190 °C are given relative to the appropriate starting compound. Solutions resulting from preparative-scale reactions were concentrated to less than 0.5 mL. Unconverted reactants and products were isolated by preparative-layer chromatography using dichloromethane as the eluent.

Quantitative GLC analysis of reactant consumption and product formation was accomplished using calibration curves constructed for each phenylisothiazole and phenylthiazole by plotting detector responses vs 10 standards of known concentration. Correlation coefficients ranged from 0.993 to 0.999.

Photodeuteration reactions were carried out on an analytical or preparative scale as above except that the solutions also contained D₂O (0.25 mL in 10 mL of benzene for the analytical reactions or 2.0 mL in 80 mL of benzene for the preparative-scale reactions). Analytical-scale reactions were monitored by removing aliquots (0.5 mL) which were dried (Na₂SO₄) and concentrated (25 to 1) and analyzed by GLC-MS. Solutions resulting from preparative-scale reactions were dried (Na₂SO₄) before concentrating and subjected to preparative-layer chromatography.

2-Phenylthiazole (1). GLC analysis of the irradiated solution showed the formation of 5-phenylisothiazole (6) (trace), 3-phenylisothiazole (4) (7%), and 4-phenylthiazole (2) (26%) with relative retentions of 1.10, 1.28, and 1.45, respectively.

4-Phenylthiazole (2). GLC analysis of the irradiated solution after concentration showed the formation of 3-phenylisothiazole (4) (trace) with a relative retention of 0.88.

5-Phenylthiazole (3). GLC analysis of the irradiated solution showed the formation of 4-phenylisothiazole (2) (7%) with a relative retention of 1.06.

3-Phenylisothiazole (4). GLC analysis of the irradiated solution showed the formation of 2-phenylthiazole (1) (trace) and 4-phenylthiazole (2) (27%) with relative retentions of 0.78 and 1.14, respectively.

4-Phenylisothiazole (5). GLC analysis of the irradiated solution before or after concentration failed to show the formation of any phototransposition product.

5-Phenylisothiazole (6). GLC analysis of the irradiated solution showed the formation of 2-phenylthiazole (1) (1%), 3-phenylisothiazole (4) (6%), 4-phenylthiazole (2) (17%), and 5-phenylthiazole (3) (0.7%) with relative retentions of 0.91, 1.17, 1.33, and 1.63, respectively.

2-Deuterio-5-phenylthiazole (2-D-3). GLC analysis after irradiation (3.5 h) showed 50% consumption of the reactant and the formation of deuterated 4-phenylisothiazole in 12% yield. GLC-MS analysis of this product showed signals at *m/e* 134 (23.9%) for 3-D-5 and *m/e* 135 (28.3%) for 5-D-5. GLC-MS analysis of the reactant showed signals at *m/e* 134 (98.3%) and *m/e* 135 (36.5%) before irradiation and *m/e* 134 (93.7%) and *m/e* 135 (38.9%) after irradiation.

5-Deuterio-3-phenylisothiazole (5-D-4). GLC analysis after irradiation (20 h) showed 77% consumption of the reactant and the formation of a trace quantity of 2-phenylthiazole and a 17% yield of 4-phenylthiazole. GLC-MS analysis of this latter product showed signals at *m/e* 162 (83.5%) and *m/e* 134 (100%; DC₂=N) for 2-D-2.

5-Deuterio-4-phenylisothiazole (5-D-5). GLC analysis after irradiation (0.5 h) showed 50% consumption of the reactant without formation of any phototransposition products. GLC-MS analysis of the unconverted reactant showed signals at *m/e* 162 (100%) and *m/e* 135 (45.0%) for 5-D-5 but no signal at *m/e* 134 for the formation of 3-D-5. The photolysate was evaporated to dryness and the residue sublimed (80 °C, 0.6 Torr) to give white crystals: mp 36–37 °C; ¹H NMR (CDCl₃) δ 7.35–7.80 (m, 5H), 8.75 (s, H-3) with no signal at 8.65 due to a C-5 proton.

Acknowledgment. The authors gratefully acknowledge the Camille and Henry Dreyfus Foundation for partial support for the purchase of the NMR spectrometer and the Perkin-Elmer Corporation for support in the form of equipment grants.

(38) Olofson, R. A.; Landesberg, J. M.; Berry, R. O.; Leaver, D.; Robertson, W. A. H.; McKinnon, D. M. *Tetrahedron*, 1966, 22, 2119–2134.

(39) Arnold, Z.; Zemlicka, J. *Collect. Czech. Chem. Commun.* 1959, 24, 2385–2392.